

Parts • Service • Applications





we care!





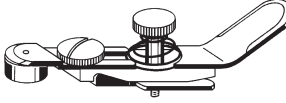
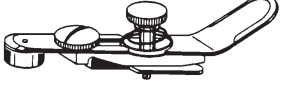
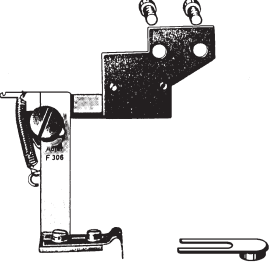
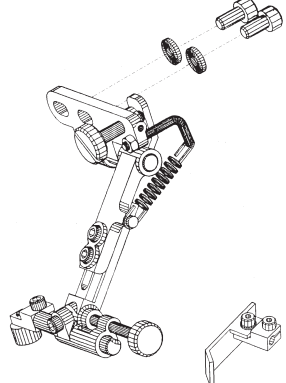
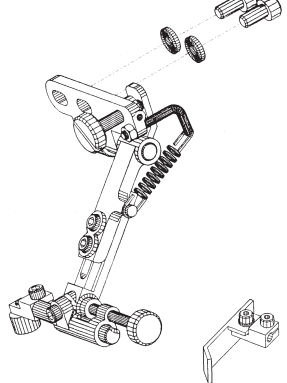
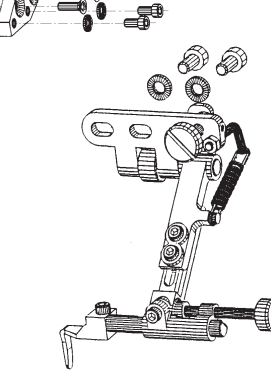
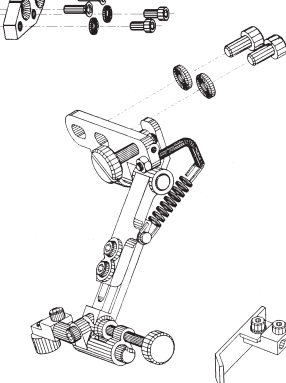
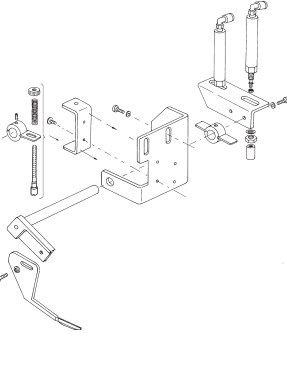
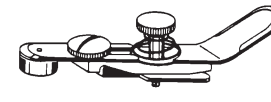

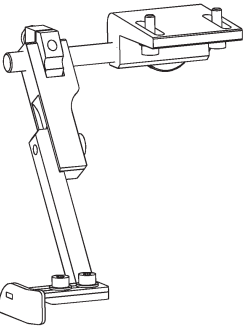
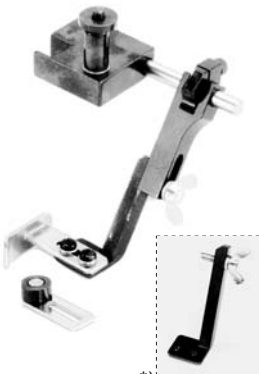
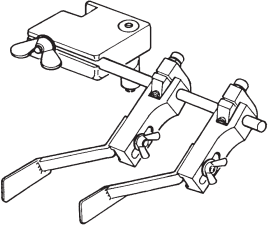

Edge-guides Kantenführungen



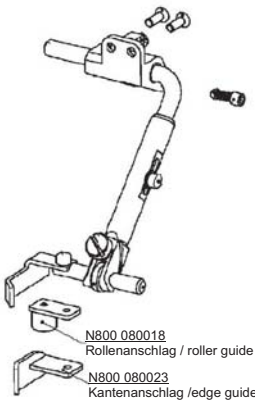
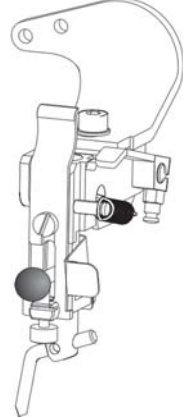
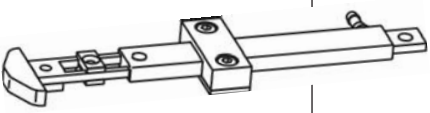

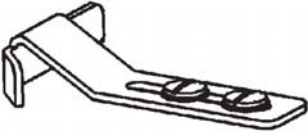
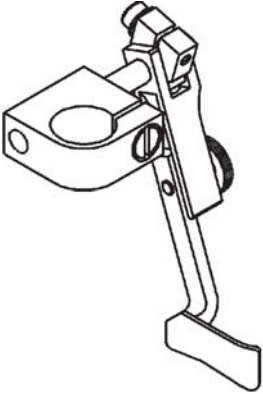
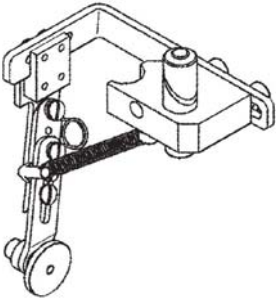
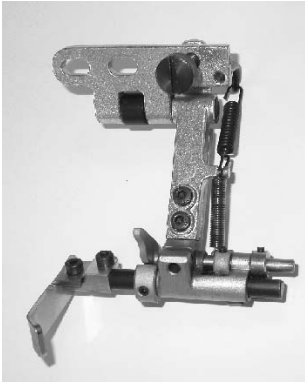

2nd Edition 11/2009





N800 015411		N800 015413		N800 045115	
	Für Klassen: for classes: 69-373 Verstellbereich: Adjustment range: 0 - 5,5 mm		Für Klassen: for classes: 69-373 H Verstellbereich: Adjustment range: 0 - 5,5 mm		Für Klassen: for classes: 69 Verstellbereich: Adjustment range: 0 - 30 mm
<p>Rollenanschlag abschwenkbar. <i>Hinged roller guide.</i></p>		<p>Rollenanschlag abschwenkbar. <i>Hinged roller guide.</i></p>		<p>Kombinierter Rollen- und Geradanschlag, links hochschwenkbar. Anschlag in der Höhe mittels Rändelschraube einstellbar. <i>Combined hinged roller and straight stop, left, which can be adjusted in height by means of a knurled-head screw.</i></p>	
N800 075013		N800 075105		N800 075101	
	Für Klassen: for classes: 69-372 69-373 69-FA-373 Verstellbereich: Adjustment range: 0 - 30 mm		Für Klassen: for classes: 204-370 205-370 Verstellbereich: Adjustment range: 0 - 30 mm		Für Klassen: for classes: 267-273, 267-FA-273 267-273-NH1 267-FA-273 -NH1 268-273 268-FA-273 268-273-NH1 268-FA-273 -NH1
<p>Kombinierter Rollen- und Geradanschlag, rechts, hochschwenkbar. Anschlag in der Höhe mittels Rändelschraube einstellbar. <i>Combined hinged roller and straight stop, right, which can be adjusted in height by means of a knurled-head screw.</i></p>		<p>Kombinierter Rollen- und Geradanschlag, rechts, hochschwenkbar. Anschlag in der Höhe mittels Rändelschraube einstellbar. <i>Combined hinged roller and straight stop, right, which can be adjusted in height by means of a knurled-head screw.</i></p>		<p>Nahtmittenführung, hochschwenkbar. für Ausstepparbeiten. Anschlag in der Höhe mittels Rändelschraube einstellbar. <i>Center guide, swing up, for top stitching, which can be adjusted in height by means of a knurled-head screw.</i></p>	
N800 075001		N800 085021		N800 015412	
	Für Klassen: for classes: 267-73 267-373 267-273 267-FA-73-1 267-FA-373 267-FA-273-1 268 alle UKL außer / except -82 269-73 267-373 Verstellbereich: Adjustment range: 0 - 30 mm		Für Klassen: for classes: 268-FAP-273 ..E67/8 .. 10		Für Klassen: for classes: 269-373 Verstellbereich: Adjustment range: 0 - 5,5 mm
<p>Kombinierter Rollen- und Geradanschlag, rechts, hochschwenkbar. Anschlag in der Höhe mittels Rändelschraube einstellbar. <i>Combined hinged roller and straight stop, right, which can be adjusted in height by means of a knurled-head screw.</i></p>		<p>Nahtmittenführung, hochschwenkbar. für Ausstepparbeiten. Anschlag in der Höhe mittels Rändelschraube einstellbar. <i>Center guide, swing up, for top stitching, which can be adjusted in height by means of a knurled-head screw.</i></p>		<p>Rollenanschlag abschwenkbar. <i>Hinged roller guide.</i></p>	

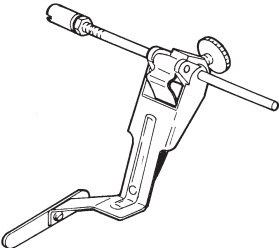

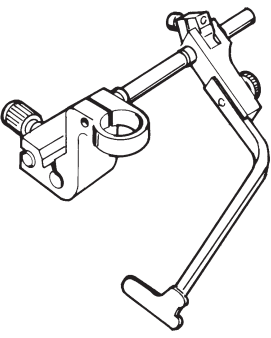

N800 040367		N800 045135		N800 045142	
	Für Klassen: for classes: 367 Verstellbereich: Adjustment range: 0 - 42 mm		Für Klassen: for classes: 370-OT 370-DO2-222 396-OT; -OF Verstellbereich: Adjustment range: 0 - 40 mm		Für Klassen: for classes: 550-16- Verstellbereich: Adjustment range: 0 - 20 mm
Kantenanschlag, rechts, hochschwenkbar <i>Edge guide r/h, can be raised.</i>		Anschlag, hochschwenkbar. <i>Guide, can be raised.</i>		Anschlag, rechts, hochschwenkbar. <i>Guide, r/h, can be raised.</i>	
N800 045017		N800 045141		N800 075006	
	Für Klassen: for classes: 467-73 467-FA-73 467-183080 467-183081 767 Verstellbereich: Adjustment range: 0 - 30 mm	 <small>*) N800_005144</small>	Für Klassen: for classes: 467-73-G2 467-273-G2 467-FA-73-G2 467-FA-273G2 767-373 767-FA-373 467-183080 467-183081 768-R374 768-FA-R373 *) für Klasse for class: 467-65		Für Klassen: for classes: 467-73 467-FA-73 477-070-G2 477-170-G2 767 467-183080 467-183081 768-R374 768-FA-R373 Verstellbereich: Adjustment range: 0 - 30 mm
Kombinierter Rollen- und Geradanschlag, links, hochschwenkbar. Anschlag in der Höhe mittels Rändelschraube einstellbar. <i>Combined hinged roller and straight stop, left, which can be adjusted in height by means of a knurled-head screw.</i>		Anschlag, rechts, hochschwenkbar. <i>Guide, r/h, can be raised.</i> Verstellbereich / Adjustment range: 0 - 45 mm		Kombinierter Rollen- und Geradanschlag, rechts, hochschwenkbar. Anschlag in der Höhe mittels Rändelschraube einstellbar. <i>Combined hinged roller and straight stop, right, which can be adjusted in height by means of a knurled-head screw.</i>	
N800 075103		N800 025009		N800 045011	
	Für Klassen: for classes: 477-070-2 467-65-273 467-65-FA-273 767-273 767-FA-273		Für Klassen: for classes: 767 467-183080 467-183081 Verstellbereich: Adjustment range: 0 - 50 mm		Für Klassen: for classes: 767-373 767-FA-373 467-183080 467-183081 Verstellbereich Adjustment range: 0 - 20 mm
Nahtmittenführung, hochschwenkbar für Ausstepparbeiten. Anschlag in der Höhe mittels Rändelschraube einstellbar. <i>Center guide, swing up, for top stitching, which can be adjusted in height by means of a knurled-head screw.</i>		Kantenanschlag, zweiteilig, rechts hochschwenkbar. <i>Edge guide two-piece r/h, can be raised.</i>		Anschlag, rechts, hochschwenkbar. <i>Guide, r/h, can be raised.</i>	

N800 005611		N800 045111		N800 080001	
	<p>Für Klassen: for classes:</p> <p>767-FA-273 767-FAS-473 768-274-FLP 768-FA-273</p>		<p>Für Klassen: for classes:</p> <p>467 767</p>		<p>Für Klassen: for classes:</p> <p>669 867 868 869</p>
<p>Nahtmittenföhrung , pneum. verstellbare H6he, f6r Ausstepparbeiten. Anschlag in der H6he mittels Schwenkhebel einstellbar. <i>Center guide, pneumatically adjustable height for top stitching. Stop adjustable in height by means of an adjustment screw.</i></p>		<p>Kombinierter Rollen- u. Geradanschlag, links, hochschwenkbar. <i>Combined hinged roller & straight stop, left</i></p>		<p>Kantenanschlag rechts, mit Rolle, hochschwenkbar. <i>Edge guide, right, with roll, can be swivelled upwards</i></p>	
N800 080004		N800 080021		N800 080030	
	<p>Für Klassen: for classes:</p> <p>669 838 867 1-Ndl. 868 869 1-Ndl. 887 888</p>	 <p>N800_080018 Rollenanschlag / roller guide N800_080023 Kantenanschlag /edge guide</p>	<p>Für Klassen: for classes:</p> <p>867 868</p>		<p>Für Klassen: for classes:</p> <p>838, 887, 888</p>
<p>Verstellbereich: Adjustment range: 0 - 30 mm</p>		<p>Verstellbereich: Adjustment range: 0 - 30 mm</p>		<p>Verstellbereich: Adjustment range: 0,5 - 5 mm</p>	
<p>Kombinierter Rollen- und Geradanschlag, rechts, hochschwenkbar, h6henverstellbar. <i>Combined roller and straight guide, right, hinged, elevation adjustment.</i></p>		<p>Kombinierter Rollen- u. Geradanschlag, rechts, manuell hochschwenkbar, Kantenabstand mittels R6ndelschraube einstellbar. <i>Combined hinged roller & straight stop, right, which can be adjusted in height by means of knurled screw.</i></p>		<p>N6hgf6hrung, abklappbar <i>Edge guide, tiltable</i></p>	
N800 005646		N800 005655		N800 005650	
	<p>Für Klassen: for classes:</p> <p>867 - 1 Ndl.</p>		<p>Für Klassen: for classes:</p> <p>867 - 2 Ndl 868 - 2 Ndl</p>		<p>Für Klassen: for classes:</p> <p>for Classic: alle 2 Ndl. all 2-needle</p> <p>867, 868, 869</p>
<p>(Lieferumfang mit pneum. Anschlu6paket) <i>(delivery content with pneumatic connection)</i></p>		<p>Verstellbereich: Adjustment range: 0 - 40 mm</p>		<p>Verstellbereich: Adjustment range: 0 - 25 mm</p>	
<p>Kantenanschlag, pneumatisch schaltbar, zum wechselseitigen Abrufen zwei vorw6hlbarer Kantenabst6nde. <i>Edge guide, pneumatic driven, to activate two preselected seam margins</i></p>		<p>Nahtmittenf6hrung, hochschwenkbar <i>Seam center guide, can be swivelled upwards</i></p>		<p>Nahtmittenf6hrung, elektro-pneumatisch (erfordert Ausgleichsf66e) <i>Electro-pneumatic centre guide. (Can only be used together with a compensating foot)</i></p>	

N800 080022		N800 045144			
 <p>N800 080019 in Kombination mit N800 080020 ermoglicht zwei Kantenabstande. With N800 080019 in combination with N800 080020, you can have 2 edge distances.</p>	<p>Fur Klassen: for classes:</p> <p>867 alle Flachbett all flat bed-<i>ms</i></p> <p>Verstellbereich: Adjustment range: 0 - 32 mm</p>		<p>Fur Klassen: for classes:</p> <p>550-16-23 550-16-26</p> <p>Verstellbereich: Adjustment range: 0 - 40 mm</p>		
<p>Lineal, zur Befestigung auf Greiferabdeckplatte <i>Edge guide, to be attached to the r/h hook cover</i></p>		<p>Kantenanschlag, manuell abschwenkbar <i>Hinged edge guide, swivel manual</i></p>			
N800 V91161		N800 V91179		N800 V91431	
	<p>Fur Klassen: for classes:</p> <p>767 768 1-Ndl.</p> <p>Verstellbereich: Adjustment range: 3 - 5 mm</p>		<p>Fur Klassen: for classes:</p> <p>767 768 1-Ndl.</p> <p>Verstellbereich: Adjustment range:</p>		<p>Fur Klassen: for classes:</p> <p>767 768 1-Ndl.</p> <p>Verstellbereich: Adjustment range: 3 - 5 mm</p>
<p>Rollenanschlag fur Ausstepparbeiten von Kapp- und Koffernahen. Hochschwenkbarer Rollenanschlag <u>links</u> der Nadel. <i>Roller guide for topstitching of felled seams and seams on suitcases (French seaming). Swivable roller guide on the <u>left</u> of the needle</i></p>		<p>Geradanschlag, manuell hochklappbar, hohenverstellbar. Verstellbare Anschlagswerte, wahlweise zw. 2 Werten (in Stufen von 3 mm) <i>Straight stop, can be tilted up, height-adjustable. Adjustable edge guide values, 2 alternate values (in 3 mm steps)</i></p>		<p>Rollenanschlag fur Ausstepparbeiten von Kapp- und Koffernahen. Hochschwenkbarer Rollenanschlag <u>rechts</u> der Nadel. <i>Roller guide for topstitching of felled seams and seams on suitcases (French seaming). Swivable roller guide on the <u>r/h</u> of the needle</i></p>	

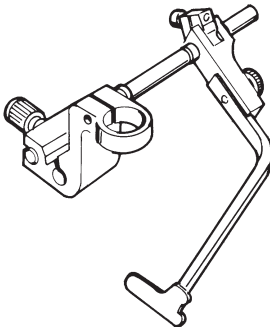

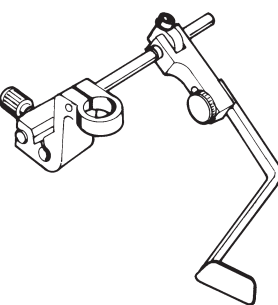
N900 012015		N900 011038		N900 011035	
	<p>Für Klassen: for classes:</p> <p>Für alle Klassen (Bekleid.)</p> <p>For all classes (garment)</p> <p>Verstellbereich: Adjustment range: 0 - 14 mm</p>		<p>Für Klassen: for classes:</p> <p>Für alle Klassen (Bekleid.)</p> <p>For all classes (garment)</p> <p>Verstellbereich: Adjustment range: 0 - 40 mm</p>		<p>Für Klassen: for classes:</p> <p>Für alle Klassen (Bekleid.)</p> <p>For all classes (garment)</p> <p>Verstellbereich: Adjustment range: 0 - 20 mm</p>
<p>Kantenanschlag rechts, abschwengbar, auf Fundamentplatte befestigt.</p> <p><i>Edge guide r/h, swivels sideways, to be fitted on the base plate.</i></p>		<p>Kantenanschlag rechts, fest auf Fundamentplatte befestigt.</p> <p><i>Edge guide r/h, fast to be fitted on the base plate.</i></p>		<p>Kantenanschlag rechts, abschwengbar, auf Fundamentplatte befestigt.</p> <p><i>Edge guide r/h, swivels sideways, to be fitted on the base plate.</i></p>	
N900 060034		N900 060035		N900 023550	
	<p>Für Klassen: for classes:</p> <p>171 173 176 271 272 273 274</p> <p>Verstellbereich: Adjustment range: 0 - 40 mm</p>		<p>Für Klassen: for classes:</p> <p>171 173 176 271 272 273 274</p> <p>Verstellbereich: Adjustment range: 0 - 40 mm</p>		<p>Für Klassen: for classes:</p> <p>171 173 273 274</p> <p>Verstellbereich: Adjustment range: 0 - 40 mm</p>
<p>Kantenanschlag rechts und links, hochschwengbar, an der Stoffdrückerstangenbuchse befestigt.</p> <p><i>Edge guide r/h or l/h, can be raised, to be fitted to the cloth presser bar bushing.</i></p>		<p>Kantenanschlag rechts und links, hochschwengbar, an der Stoffdrückerstangenbuchse befestigt.</p> <p><i>Edge guide r/h or l/h, can be raised, to be fitted to the cloth presser bar bushing</i></p>		<p>Kantenanschlag rechts, hochschwengbar, an der Stoffdrückerstangenbuchse befestigt.</p> <p><i>Edge guide r/h, can be raised, to be fitted to the cloth presser bar bushing.</i></p>	
N900 020021		N900 023421		N900 040038	
	<p>Für Klassen: for classes:</p> <p>171, 176 211, 212 243 244 271 272</p> <p>Verstellbereich: Adjustment range: 0 - 50 mm</p>		<p>Für Klassen: for classes:</p> <p>171, 173 176 211, 212 243, 244 265 271, 272 273, 274 933, 934</p> <p>Verstellbereich: Adjustment range: 0 - 40 mm</p>		<p>Für Klassen: for classes:</p> <p>175 176</p> <p>Verstellbereich: Adjustment range: 5 + 10 mm</p>
<p>Kantenanschlag rechts, hochschwengbar, an der Stoffdrückerstangenbuchse befestigt.</p> <p><i>Edge guide r/h, can be raised, to be fitted to the cloth presser bar bushing.</i></p>		<p>Kantenanschlag rechts, hochschwengbar, an der Stoffdrückerstange befestigt.</p> <p><i>Edge guide r/h, can be raised, to be fitted to the cloth presser bar bushing.</i></p>		<p>Kantenanschlag rechts, von oben einschwenkbar, mit Rasterung 2 mm, 5 mm und 10 mm rechts der Nadel</p> <p><i>Edge guide, swivable from above, with graduations 2, 5 and 10 mm to the right of the needle</i></p>	

N900 020031		N900 072711		N900 043361	
	<p>Fur Klassen: for classes:</p> <p>171, 173 176 271, 272 273, 274 933</p> <p>Verstellbereich: Adjustment range: 0 - 50 mm</p>		<p>Fur Klassen: for classes:</p> <p>195 291, N291 292, N291 294 295 8967</p> <p>Verstellbereich: Adjustment range: 0 - 50 mm</p>		<p>Fur Klassen: for classes:</p> <p>195 243 244 291, N291 292, N292 294 295 296</p> <p>Verstellbereich: Adjustment range: 0 - 30 mm</p>
<p>Kantenanschlag rechts, hochschwenkbar, an der Stoffdruckerstangenbuchse befestigt.</p> <p><i>Edge guide r/h, can be raised, to be fitted to the cloth presser bar bushing.</i></p>		<p>Kantenanschlag rechts hochschwenkbar, zusatzlich waagrecht ausschwenkbar, am Armkopf befestigt.</p> <p><i>Edge guide r/h, can be raised, additional horizontal to rinse, to be fitted to the arm head.</i></p>		<p>Kantenanschlag, rechts, hochschwenkbar, am Armkopf befestigt.</p> <p><i>Edge guide r/h, can be raised, to be fitted to the arm head.</i></p>	
N900 022301		N900 021258		N900 021090	
	<p>Fur Klassen: for classes:</p> <p>211 212 265 267 271 272 933 934</p> <p>Verstellbereich: Adjustment range: 0 - 40 mm</p>		<p>Fur Klassen: for classes:</p> <p>211 212 265 267 271 933 934</p> <p>Verstellbereich: Adjustment range: 0 - 40 mm</p>		<p>Fur Klassen: for classes:</p> <p>211 212 265 267 271 272 933 934</p> <p>Verstellbereich: Adjustment range: 0 - 120 mm</p>
<p>Kantenanschlag rechts, hochschwenkbar, an der Stoffdruckerstangenbuchse befestigt.</p> <p><i>Edge guide r/h, can be raised, to be fitted to the cloth presser bar bushing.</i></p>		<p>Kantenanschlag links, hochschwenkbar, an der Stoffdruckerstangenbuchse befestigt.</p> <p><i>Edge guide l/h, can be raised, to be fitted to the cloth presser bar bushing.</i></p>		<p>Kantenanschlag rechts oder links, hochschwenkbar, an der Stoffdruckerstangenbuchse befestigt.</p> <p><i>Edge guide r/h or l/h, can be raised, to be fitted to the cloth presser bar bushing.</i></p>	
N900 020023		N900 021081		N900 020041	
	<p>Fur Klassen: for classes:</p> <p>211 212 243 244 271 272</p> <p>Verstellbereich: Adjustment range: 0 - 60 mm</p>		<p>Fur Klassen: for classes:</p> <p>211 212 265 267 271 272 933 934</p> <p>Verstellbereich: Adjustment range: 0 - 80 mm</p>		<p>Fur Klassen: for classes:</p> <p>271 272 273 274</p> <p>Verstellbereich: Adjustment range: 0 - 50 mm</p>
<p>Kantenanschlag rechts und links, hochschwenkbar, an der Stoffdruckerstangenbuchse befestigt.</p> <p><i>Edge guide r/h and l/h, can be raised, to be fitted to the cloth presser bar bushing.</i></p>		<p>Kantenanschlag rechts, hochschwenkbar, an der Stoffdruckerstangenbuchse befestigt.</p> <p><i>Edge guide r/h, can be raised, to be fitted to the cloth presser bar bushing.</i></p>		<p>Kantenanschlag links, hochschwenkbar, am Nahmaschinenkopf befestigt.</p> <p><i>Edge guide r/h, can be raised, to be fitted to the sewing machine head.</i></p>	

N900 020038		N900 040032		N900 042271	
	Für Klassen: for classes: 175 275-140000		Für Klassen: for classes: 219 250 939		Für Klassen: for classes: 219 250 939
Verstellbereich: Adjustment range: 0 - 40 mm		Verstellbereich: Adjustment range: 0 - 50 mm		Verstellbereich: Adjustment range: 0 - 2 mm	
Kantenanschlag rechts, hochschwenkbar, Befestigung am Gußansatz vom Arm. <i>Edge guide r/h, can be raised, to be fitted at casted stud of the machine arm.</i>		Kantenanschlag <i>Edge guide</i>		Kantenanschlag <i>Edge guide</i>	
N900 020036		N900 040037		N900 040024	
	Für Klassen: for classes: 272-640000 272-740000		Für Klassen: for classes: 275 (in E2 enthalten) include in E2		Für Klassen: for classes: 291, N291 292, N292 294 295 (ohne Zwischen- blech / without dis- tance sheet)
Verstellbereich: Adjustment range: 0 - 50 mm		Verstellbereich: Adjustment range: 0 - 20 mm		Verstellbereich: Adjustment range: 0 - 50 mm	
Kantenanschlag rechts, hochschwenkbar, an der Stoffdrückerstangenbuchse befestigt. <i>Edge guide r/h, can be raised, to be fitted to the cloth presser bar bushing.</i>		Kantenanschlag, hochschwenkbar, Befestigung am Gußansatz vom Arm. Feste Einstellung (Rasterung) von N.M.: 2 / 5 und 10 mm. <i>Edge guide, can be raised, to be fitted at casted stud of the machine arm. Firm adjustment (preset stops) from N. M.: 2 / 5 and 10 mm.</i>		Kantenanschlag rechts, hochschwenkbar, am Armkopf befestigt. <i>Edge guide r/h, can be raised, to be fitted to the arm head.</i>	
N900 040026		N900 040030		N900 042891	
	Für Klassen: for classes: 291, N291 292, N292 294 295		Für Klassen: for classes: 291, N291 292, N292 294 295		Für Klassen: for classes: 292, N292
Verstellbereich: Adjustment range: 0 - 50 mm		Verstellbereich: Adjustment range: 0 - 60 mm			
Kantenanschlag rechts, hochschwenkbar, am Armkopf befestigt. <i>Edge guide r/h, can be raised, to be fitted to the arm head.</i>		Kantenanschlag, rechts und links, hochschwenkbar, am Armkopf befestigt. <i>Edge guide r/h or l/h, can be raised, to be fitted to the arm head.</i>		Kanten- und Mittenanschlag, hochschwenkbar, am Armkopf befestigt. <i>Edge guide and center guide, can be raised, to be fitted to the arm head.</i>	

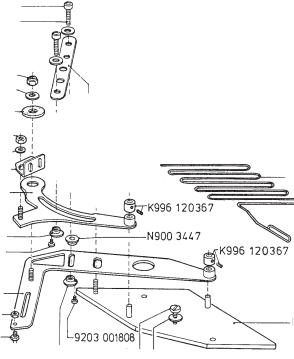
N900 020039		N900 040027		N900 092881	
	Fur Klassen: for classes: 381 382 Verstellbereich: Adjustment range: 4 - 40 mm		Fur Klassen: for classes: 697-15155 Verstellbereich: Adjustment range: 0 - 40 mm		Fur Klassen: for classes: 697-24155 Verstellbereich: Adjustment range: 0 - 13 mm
Kantenanschlag rechts, hochschwenkbar, am Nahmaschinenkopf befestigt. <i>Edge guide r/h, can be raised, to be fitted to the sewing machine head.</i>		Kantenanschlag rechts, hochschwenkbar, am Armkopf befestigt. <i>Edge guide r/h, can be raised, to be fitted to the arm head.</i>		Kantenanschlag rechts, ausschwenkbar, am Armkopf befestigt. <i>Edge guide r/h, can be to rinse, to be fitted to the arm head.</i>	

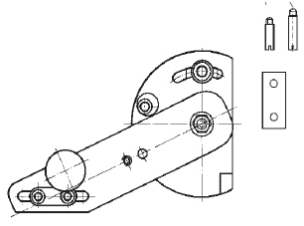
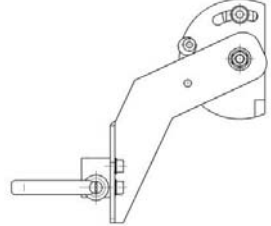
N900 003441					
					Fur Klassen: for classes: 271 E26 272 E (SO)
				Bausatz fur mitgehenden Einfasser N 014, N015 und N017 bis max. 30 mm Bandbreite. <i>Set for mobile binder N014, N015 and N017 up to max. 30 mm tape width.</i>	

N900 001941		N900 002841		N900 002631	
	Fur Klassen: for classes: 173, 175, 195, 272, 381, 382		Fur Klassen: for classes: 175		Fur Klassen: for classes: 173
Schwenkschiene fur Fuhrungsapparate / Bandfuhrungen <i>Swivel rail for guide attachments / tape guides</i>		Schwenkschiene fur Fuhrungsapparate <i>Swivel rail for guide attachments.</i>		Spezialanschlag von "unten" zum Absteppen von Hosenseitennahen <i>Special guide from below for top stitching of trousers side seams</i>	



Money back within 30 days if not totally satisfied!

If you are not 100% satisfied with the sewing result of your attachment from Dürkopp Adler, you may return it to the vendor named in the below field in this leaflet for an extended period of time. Returns will be accepted within 30 days after the purchase date. The full amount will be credited when you inform the vendor in written form about the machine class, the sewing equipment number, the fabric used, the sewing operation executed with the attachment and the problem which occurred.

We care!
DÜRKOPP ADLER
Parts & Service Center



Geld zurück innerhalb 30 Tagen, wenn Sie nicht total zufrieden sind!

Wenn Sie nicht zu 100% zufrieden mit dem Nähergebnis Ihres Apparates von Dürkopp Adler sind, können Sie ihn an den unten genannten Vertriebspartner innerhalb von 30 Tagen nach Kaufdatum zurückgeben. Sie erhalten den vollen Kaufpreis zurück, wenn Sie ihm die Maschinenklasse, die Näh-einrichtung, verwendetes Nähmaterial, die ausgeführte Nähoperation und das aufgetretene Problem schriftlich mitteilen.

We care!
DÜRKOPP ADLER
Parts & Service Center

Submitted by:
Überreicht durch:

DÜRKOPP ADLER AG

Parts & Service Center · Potsdamer Str. 190 · D-33719 Bielefeld / Germany · Telefon +49 521 925-1152 · Telefax +49 521 925-2200
Internet www.duerkopp-adler.com · E-Mail: attachments@duerkopp-adler.com